

Geotechnical & Structural Instrumentation

2022

Civil engineering solutions

Structures & Power plants

Bridges

Dams

Tunnels

Piles

Marin structures

Foundations

Slope stability

Landfills

Excavations

Embankments

Ground water

Railway & Roadway



ACE INSTRUMENT CO., LTD.

The first value in Geotechnical Instrumentation
www.aceinstrument.com



Head office

Company

ACE INSTRUMENT CO., LTD. which are a group of experts for civil instrumentation are exported to more than 30 countries and supply the civil engineering industry. We are producing our products to use in construction site, rock, environmental instruments with using our data loggers, operating software to check design validation and safety construction. Our company hopes to develop new products and technologies through challenge and innovation to create a new future.



Factory 2.

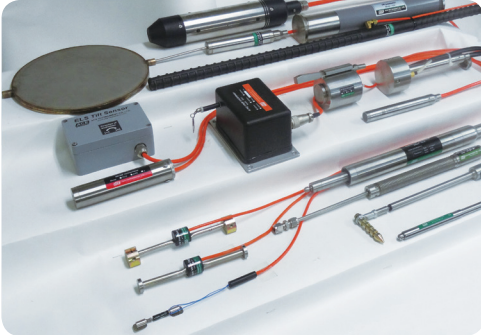

Products

Our produced civil engineering instruments are used that dams, tunnels, railways, bridges, roads, soft ground improvement work, pile test to measure load, stress, strain, earth pressure, water level, pore pressure, slope angle, physical feature of a base rock.

In addition, we also produce the in-situ test equipment, hydraulic cell for pile load test and variety of data loggers and analysis software.



Technology

ACE INSTRUMENT CO., LTD. has a world-class design, manufacturing tuning, calibration technology and output value for a vibrating wire sensor suitable for semi-permanent measurement and a strain gage sensor suitable for research purposes such as dynamic characteristic detection and model testing due to excellent responsiveness and stability. There is a variety of digital calibration equipment available for checking. Since our products are manufactured according to CE certification ISO-9001 Quality management system, we supply the highest quality products with high reliability. All of our measuring instruments have been supplied to the construction sites of 30 or more dam sites that have to measure more than 30 years, including Turkey, Iran, Indonesia and so on. In addition, the various measuring instruments of our company are supplied to construction sites of nuclear power plants that require high reliability.



Service

- Manufacturing geotechnical & structural instrumentation, the readout unit, data logger
- Installing & supervising service of the geotechnical sensor and the data logger.
- Developing the various analysis software for civil engineering monitoring.
- Technical support for geotechnical engineering.
- Facilities rental service for civil engineering.
- Inspection & calibration of sensor and facilities.
- Web monitoring service

Quality

Our company has been certified by ISO-9001 quality management system in the design, development, manufacture and service of civil engineering equipment.

Through quality management and quality innovation, we guarantee the quality and pursue the service organization in order to impress the customers.

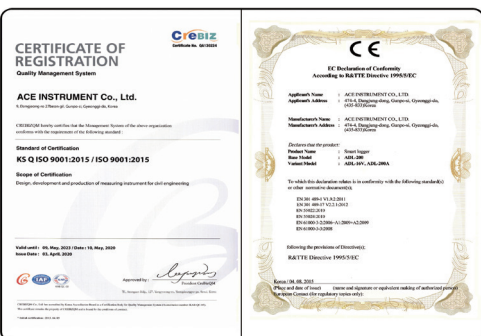

Category	Index	Instruments	Category	Index	Instruments	
Web software Data logger Readout Indicator	1	Web monitoring program	Displacement	51	VW 3D jointmeters	
	2	Smart logger		52	VW compression displacement sensors	
	3	VW data logger		53	FSG crackmeters	
	4	VW mini loggers		54	Mechanical 3D jointmeters	
	5	MEMS mini logger		55	VW soil strainmeters	
	6	VW readout unit		56	VW jointmeters	
	7	VW data recorder		57	Electrical jointmeter	
	8	FSG readout unit		58	Long range crackmeter	
	9	MEMS readout unit	Settlement	59	VW settlement gage	
	10	VW display logger		60	High sensitivity settlement systems	
	11	Dynamic data logger		61	Settlement profiler	
	12	Pneumatic readout unit		62	Current type extensometer	
	13	Water level meter		63	Magnetic sensors	
	14	Magnetic extensometer		64	Rail track monitoring system	
	15	Surge module		65	USBR type settlement probe	
	16	Voltage amplifier		66	Wire sensor type extensometer	
	17	Digital indicator		67	VW borehole rod extensometers / MPBX	
	18	Universal terminal boxes		68	VW piezometers	
Inclinometer casing	19	RC casings	Pore pressure	69	VW multi point piezometer	
	20	SC casings		70	VW vented piezometer	
	21	DC casings		Water level	71	FSG/Semiconductor piezometers
	22	WC casings			72	Lab. instruments
	23	FC casings			73	Pneumatic piezometer
Inclination Tilt	24	Digital vertical inclinometer	74	VW weir monitoring system		
	25	Digital horizontal inclinometer	75	Standpipe piezometer		
	26	Digital slope inclined inclinometer	Earth pressure	76	VW earth pressure cells	
	27	Spiral sensor probe		77	FSG earth pressure cells	
	28	Portable digital tiltmeter		78	Temperature gages	
	29	ELS tilt sensors	Temperature	79	Multi point temperature gage	
	30	ELS beam sensors		80	Digital tape extensometer	
	31	VW inclinometer	Tunnel instrumentation	81	VW convergence meters	
	32	MEMS inclinometers		82	Rock bolt pull tester set	
	33	VW vertical multi point inclinometers		83	Geodetic targets	
	34	MEMS vertical, horizontal multi point inclinometers		84	Tunnel convergence monitoring system	
	35	Serial type multi point inclinometers		85	VW NATM Shotcrete stress cells	
	36	Pendulum system		86	Mechanical extensometers	
Load	37	VW load cells		87	VW rod extensometers / MPBX	
	38	FSG load cells		88	VW rock bolt stressmeters	
	39	Hydraulic load cells	Rock instrumentation	89	VW borehole rock stressmeters	
	40	FSG large capacity load cells		90	VW soft inclusion stress cells	
	41	Hydraulic cells for pile load test		91	VW borehole pressure cell	
Strain Stress	42	VW spot weldable strain gages		92	VW biaxial stressmeter	
	43	VW weldable strain gages		93	3D rock borehole deformation gage & data logger	
	44	VW embedment strain gages	94	2D borehole deformation gage		
	45	FSG strain gages	95	Rock borehole pressuremeter		
	46	VW rebar stressmeters	In-situ tester	96	Borehole pressuremeter	
Displacement	47	VW strand strainmeter		97	Borehole shear tester	
	48	Plastic crackmeters	Support item	98	Portable spot welder	
	49	VW crackmeters		99	Sealing kits	
	50	VW waterproof crackmeters		100	Signal cables	

1

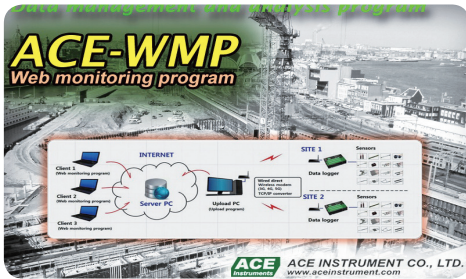

Web monitoring program

ACE-WMP Web monitoring program is for sharing the information and for supporting the prompt decision-making with the person concerned under construction at a site. The measured data is saved to the server computer by internet network. It is program that drawing up the measuring report, making a graph of engineering unit, giving an alarm, and lookup of a real-time measuring data are possible on the basis of the saved data. ACE-WMP can draw up the report using all computers that web browser is installed at the remote place, so you can work quickly and efficiently. ACE-WMP is web monitor center program that we developed for information construct at the company of civil and building construction, or engineering company of design, supervision, and measuring. It is a rental service for automatic measure using the web monitoring program as rental type by the month period without the construction cost of the system or the server computer. And we carry out the OEM development service as inexpensive cost depending on the customer's requesting specification and project condition.

2

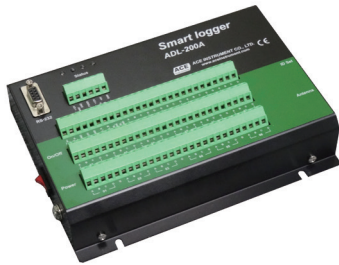

Smart logger

ADL-200A Smart logger is our company's top model static data logger. It is a full range logger that connects 16-channel vibrating wire sensor and 16-channel analog sensors (temperature sensor, mV sensor, FSG sensor, sequential serial communication sensor, etc.).

Data loggers operate in proportion to the number of different types of sensors installed in the field. Therefore, even in small or large sensor installations, up to seven sets of smart logger ADL-200A can be controlled by zigbee wireless or wired communication. Up to 112 vibrating wire sensors and 112 analog sensors can be connected and controlled in a single system simultaneously.

Model	ADL-200A
Applied sensor	VW, mV, FSG, temperature and serial communication sensor
Sensor channel	VW sensor 16ch, analog sensor 16ch
Accuracy	VW sensor 0.05% FSR, analog sensor 0.1% FSR
Input	12 VDC
Logger max. connection quantity	7set / 112 Ch
External modem	3G ~ 5G modem (smart logger - PC)

3



VW data logger

ADL-16V VW data logger is a data logger for connecting 16-channel vibrating wire sensor and temperature sensor. It is designed to be used mainly for vibrating wire sensor, which is frequently used and installed and operated in civil works. The ADL-16V interlocks the data logger in proportion to the number of vibrating wire sensors installed in the field. Therefore, even in small or large sensor installations, up to seven data loggers can be controlled by zigbee wireless or wired communication. Up to 112 vibrating wire sensors and 112 temperature sensors can be connected and controlled in a single system simultaneously.

Model	ADL-16V
Applied sensor	VW, mV, temperature sensor
Sensor channel	VW sensor 16ch, analog sensor 16ch
Accuracy	VW sensor 0.05% FSR, analog sensor 0.1% FSR
Input	12 VDC
Logger max. connection quantity	7set / 112 Ch
External modem	3G ~5 G modem (VW data logger - PC)

4

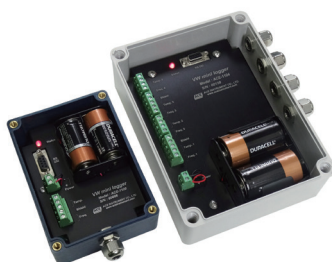

VW mini loggers

ACE-1100 VW mini logger connects to 1 VW sensor, it can automatically measure it with high precision and low cost for a long time. ACE-1104 can connect to 4 VW sensors. VW mini logger is useful for unmanned operation, connecting the vibrating wire sensor individually such as few VW displacement sensor, VW piezometer, VW crackmeter on site for the safety check, measuring the water level. Data can stores 6000 points and selects frequency signal & temperature sensor, it boasts highest performance and confidence among contemporary mini loggers regardless of country.

Model	ACE-1100	ACE-1104
Applied sensor	1ch vibrating wire	4ch vibrating wire
Frequency range	450 ~ 6000Hz	
Resolution	0.1Hz	
Accuracy	0.02% FSR	
Memory	6000 point read / record	32000 point read / record

5



MEMS mini logger

ACE-900 MEMS mini logger is developed specifically for MEMS (Micro Electro Mechanical System) tilt sensors and is designed as 2-channel to simultaneous measurement of 2-axis sensors. It is a mini data logger that can measure MEMS inclinometer, voltage(mV) sensor and current(mA) sensor, also can do for long-term unattended automation. The power supply is basically equipped with 4EA of AA class alkaline batteries. It is designed with low power and can be used without battery replacement for 6 months.

Model	ACE-900
Applied sensor	MEMS, ELS, 4~20mA sensor, potentiometer
Measurement range	-12V ~ 12V / 4 ~ 20mA
Resolution	0.1mV / 0.001mA
Memory	30000 point
Input	6.0 VDC

6



VW readout unit

ACE-800 VW readout unit is the smallest, and high quality product in the world. It can be accessed to vibrating wire sensor. ACE-800 is the best class type product that has no anxiety of defect by using four membrane switches, it is easy to measure due to concurrent display mode, the remaining battery lifetime, RTD, the thermistor temperature and the selected frequency units by using the large screen. ACE-800 also can implement the measurement at night time with backlight function, and it can be used for 40 hours continuously with one time charge, and it is the world best product that can be used in any unfavorable condition because of being manufactured with waterproof ABS case.

Model	ACE-800
Applied sensor	Vibrating wire sensor
Frequency range	450 ~ 6000Hz
Displayed units	Hz, μ sec, 10^3 Hz ² , °C, $\mu\epsilon$ 0.391, $\mu\epsilon$ 0.7756, $\mu\epsilon$ 3.304, $\mu\epsilon$ 4.062
Resolution	0.1Hz / Temperature sensor 0.1°C
Accuracy	0.02% FSR

7



VW data recorder

ACE-1000 VW data recorder for the specialist that can read VW sensor, store by its number, and transmit the data to computer by RS-232 communication and the exclusive program. It is the data logger with high reliability that can store 4000 points of measured values into max. 64 ID. It displays 5 types of engineering mode such as the Hz, 10^3 Hz², μ sec, μ strain, temperature with large screen, and built in backlight function, auto power break function.

ACE-1000 adopts the nickel hydrogen battery to measure for 30 hours continuously with one time charge, and ABS case for waterproof and impulse endurance.

Model	ACE-1000
Applied sensor	Vibrating wire sensor
Memory	Max. 64 ID / 4000 point
Frequency range	450 ~ 6000Hz
Displayed units	Hz, μ sec, 10^3 Hz ² , °C, $\mu\epsilon$ 0.3911, $\mu\epsilon$ 0.7756, $\mu\epsilon$ 3.304, $\mu\epsilon$ 4.062
Resolution	0.1Hz / Temperature sensor 0.1°C
Accuracy	0.02% FSR

8



FSG readout unit

ACE-600A FSG readout unit is an electrical sensor readout unit contacting sensory tools (so-called strain meters). The ACE-600A is easily accessible to any foil strain gage of 120Ω or 350Ω gage of input resistance full, half and quarter bridges. There is a max. 32ea of programming ID setting function. By setting the conversion coefficient, zero point, and unit of use for each ID, you can measure the final engineering unit value required by the user according to the set ID.

Model	ACE-600A
Applied sensor	FSG sensor (foil strain gage)
Bridge type	full bridge, half bridge, quarter bridge
Input resistance	120Ω, 350Ω
Resolution	1×10^{-6} strain
Accuracy	$\pm 0.1\%$ FSR

9

MEMS readout unit

ACE-1500 MEMS readout unit which is a versatile readout unit can measure MEMS sensor, ELS(Electrolytic Level Sensor), voltage sensor(mV), current sensor(mA), thermistor and platinum resistance temperature sensor(PT-100). MEMS readout unit can output two sensors A and B at the same time. It can be used in checking battery residual, measurement voltage(mV), current(mA), thermistor and PT-100 temperature measurement, backlight function.

Model	ACE-1500
Applied sensor	MEMS, ELS, 4~20mA sensor, potentiometer
Measurement range	±12V, ±5000mV, 4~20mA, -40~105°C
Accuracy	±0.1% FSR
Displayed units	V, mV, mA, °C

10

VW display logger

ACE-1100D VW display logger is a 1ch logger that is a highly efficient data logger that can be used for long-term automated measurement and is also a displayer. Depending on the function key selection, data storage, data display and storage can be selected, and automatic measurement can be performed for 6 months by connecting a vibrating wire sensor. ACE-1100D can be used by connecting battery or always power.

Model	ACE-1100D
Applied sensor	Vibrating wire sensor
Frequency range	450~6000Hz
Resolution	0.1Hz / Temperature sensor 0.1°C
Memory	32000 point read/record
Display	16x2 character LCD

11

Dynamic data logger

ADL-300 dynamic data logger can measure dynamic data by connecting FSG(foil strain gage) sensor, voltage(mV) and current(mA) sensor. It is manufactured separately for FSG sensor and voltage sensor. There are dynamic measurement mode and static measurement mode functions, so it can be changed and used according to the site situation. In dynamic measurement mode, one ADL-300 dynamic data logger can be directly controlled from a PC. In static measurement mode, ADL-300 can be connected and controlled by up to 16 units by applying RS-485 communication.

Model	ADL-300
Applied sensor	FSG, mV, mA sensor
Sensor channel	8 ch
Sampling rate	10, 20, 50, 100, 250, 500Hz/sec
Logger max. connection quantity	16set (128ch)
PC interface	USB, RS-232, RS-485
Memory	External SD memory

12

Pneumatic readout unit

ACE-2500 pneumatic readout is easily connected through one touch coupler of pneumatic sensor. The nitrogen gas pressure acting on the sensor can be measured up to maximum of 20 bar. ACE-2500 pneumatic readout consists of readout unit and pressure sensors to measure the gas pressure and nitrogen gas tank inside of the shock resistance water-proofing case. It can connect with our pneumatic piezometer, earth pressure cell and settlement gage.

Model	ACE-2500
Applied sensor	Pneumatic sensor
Measurement range	0~20bar (290psi)
Accuracy	±0.1% FSR (0.02bar)
Dimensions	185x300x450mm

13

Water level meter

4650 Water level meter consists of a reel frame with a buzzer and a light, a graduated tape and a probe. It is designed to activate the buzzer sound and indicator light when the probe is lowered down the borehole and comes into contact with water. An important element steel tape is reinforced with wire rope and then polyethylene coating is applied to make it strong and soft. There is no risk of disconnection or short circuit as the probe and tape connection parts are also mechanically treated. Semi-permanent precision measurement is possible. When using a PVC stand pipe, it can be operated by installing a filter tip.

Model	4650	4550 (magnetic indicator combined)
Measurement range	50m ~ 100m / 150m ~ 500m	
Resolution	1mm	
Weight	2.5 ~ 15kg	
Dimensions	152(W) x 278(L) x 282(H)mm / 400(W) x 400(L) x 400(H)mm	
Density / Material	50µm / PE or Ceramic filter	

14



Magnetic extensometer

4680 Magnetic extensometer is used to measure a settlement or a heave in fills, foundations and dams. Magnetic extensometer consists of sensing rings, a magnet indicator, an access pipe, telescopic sections and an end is anchored in stable ground, the depth of each magnet is referenced to a datum ring that is fixed to the bottom of the access pipe. The sensing rings include plate ring, spider ring and datum ring. When a probe is lowered down inside the access pipe and enters a magnetic field, the lamp turns on and the buzzer rings. The tape is graduated in millimeter. The tape graduations refer to the depth of the sensing ring.

Model	4680	4550 (water level combined)
Measurement range	50m ~ 100m / 150m ~ 500m	
Resolution	1mm	
Weight	2.5 ~ 15kg	
Dimensions	152(W) x 278(L) x 282(H)mm / 400(W) x 400(L) x 400(H)mm	

15



Surge module

ACE-SAM Surge module is built in diode, arrester, protective PCB to remove the plasma and excess-current through the cable by the strong thunderbolt. On the site that data logger with sensor is very important, and that the semi-permanent measuring is required, ACE-SAM has to be attached on the sensor or logger.

Model	ACE-SAM
Applied sensor	All type sensor
Break down voltage	27 V
Peak current	10kA / Line, 20kA / Pair
Temperature range	-20 ~ 70°C
Response speed	Less than 1 nano-sec

16



Voltage amplifier

VA10 Voltage amplifier is a device for restoring the strength of the measured voltage caused by the increase of the resistance of the cable core thickness and the drop of the DC voltage. The output voltage of the voltage amplifier is normally 12VDC and should be attached to the cable extension every 500m for long distance transmission.

Model	VA10
Applied sensor	mV sensor
Output voltage	12 VDC
Min. amp voltage	3.3 VDC
Max. resistance	60Ω
Case material	AL diecast

17



Digital indicator

ACE-40D Digital indicator is directly connected to our FSG load cell and displayed in units of direct load(ton-f), which can be useful for emergency situations or maintenance on site. It is also possible to install indicators directly connected to FSG load cells in multiple locations in a multi-box.

Model	ACE-40D
Measurement range	-30 ~ +30 mV/V
Applied voltage	5 VDC
Sampling rate	50 time / sec
Accuracy	±0.1% FSR
Dimensions	150 x 150 x 100mm

18



Universal terminal boxes

7012, 7024 Universal terminal boxes can be wired inside the terminal box by tying the signal cables of measuring devices installed in several places in units of 5 to 12 between nearby sensors due to the nature of large civil works. Model 7012 can connect up to 12 sensors and Model 7024 can connect up to 24 sensors, which is useful in large sites or a large amount of sensor cable aggregation.

Model	7012	7024
Applied sensor	All type	
Connectional channel of sensor	Up to 12EA	Up to 24EA
Material	ABS case	
Dimensions	280 x 190 x 180mm	350 x 250 x 180mm
weight	2.0kg	3.0kg

19



RC casings

RC casing is a fitting-type structure processed by male and female without a connecting sleeve (coupling). The inner guide groove is a highly reliable, high-precision cutting casing processed in quarters by a broaching machine. The surface of RC casing was machined inside and outside diameter by CNC turning center. The connection part is a snap-in type and has a precise structure that does not come off when inserted. When inserting the RC casing for waterproofing and reinforcing the strength of the connection, be sure to apply ABS solvent to the surface before connecting. It is a high-strength product with very high breaking strength as a product that shortens working time by eliminating the need for riveting or winding tape after bonding.

Model	RC70	RC85
Diameter	Ø59 x Ø70mm	Ø73 x Ø85mm
Cutting length	1555mm, 3055mm	
Spiral	Less than 0.3° / 3m	
Load test	More than 600kg·f	

20



SC casings

SC casing is as standard casing, highly reliable and precise product that the connected part between guide groove and coupling inside of the casing is processed. This product needs the coupling, and the external diameter of coupling is similar to the external diameter of the casing. This product is more fitted when the setting depth is deep. In case of installation, ABS solvent, POP rivet, and mastic tape are required. This product is highly reliable product that the proper intensity, the softness, and the twisted angle is guaranteed.

Model	SC70	SC85
Diameter	Ø59 x Ø70mm	Ø73 x Ø85mm
Coupling OD	Ø70mm	Ø90mm
Cutting length	1500mm, 3000mm	
Spiral	Less than 0.3° / 3m	
Load test	More than 320kg·f	

21



DC casings

DC casing is the high-precision casing which the guide grooves inside of inclinometer casing and the connecting parts of the coupling are processed by a broaching machine. The outside surface of DC casing is processed by CNC lathe, and it is finished by O-ring. DC casing is designed as snap-in type. So after taking off the protective tube of O-ring, it can be directly inserted. DC casing is possible to install quickly. ABS bond is unnecessary. And to rivet and to tape is unnecessary because DC casing is waterproof by O-ring.

Model	DC70	DC85
Diameter	Ø59 x Ø70mm	Ø73 x Ø85mm
Cutting length	1555mm, 3055mm	
Spiral	Less than 0.3° / 3m	
Load test	More than 320kg·f	

22



WC casings

WC casing is a high-reliability, high-precision cutting type product that processes all parts using a broaching machine and a CNC turning center. This product can be installed quickly by inserting the connecting wire into the casing connection part and it is waterproofed by O-ring, so subsequent processes such as riveting and tape are unnecessary. There is no protrusion of the outer diameter of the casing at the connection.

Model	WC70	WC85
Diameter	Ø59 x Ø70mm	Ø73 x Ø85mm
Cutting length	1555mm, 3055mm	
Spiral	Less than 0.3° / 3m	
Load test	More than 320kg·f	

23



FC casings

FC casing is cut into a length of 3m from the finished casing in a plastic extruder. It is a flexible product with a twist angle of less than 0.5°/3m and a stiffness of 250kg·f or more. FC casing is useful when the installation depth is less than 20m. FC casing needs coupling when connecting. There are three types of FC-64, 70 and 85. The outer diameter of the sleeve of the FC-64 casing is Ø70mm. It is easy to install because it fits into the inner diameter of a normal drilling drill NX (Ø76mm).

Model	FC64	FC70	FC85
Diameter	Ø53.6 x Ø60.6 x Ø64mm	Ø58 x Ø66 x Ø70mm	Ø72.2 x Ø80.8 x Ø85mm
Cutting length	3000mm		
Spiral	Less than 0.5° / 3m		
Load test	More than 250kg·f		

24



Digital vertical inclinometer

Digital vertical inclinometer consists of a probe, a bluetooth cable reel and a cable guide. download and use native app for your smartphone. This product has the ultimate quality of ultra-light, high accuracy, high reliability and high response. The cable reel and smartphone are linked with bluetooth and can use for 40 consecutive hours. The operating app has data storage, data viewing and e-mail sending function.

Model	5481
Applied sensor	2-MEMS sensor
Measurement range	$\pm 30^\circ$ (horizontal)
Resolution	0.005mm / 500mm
System accuracy	± 2 mm / 25m
Data logger	App. based smartphone

25



Digital horizontal inclinometer

Digital horizontal inclinometer is the device for precisely measuring vertical displacement such as subsidence or uplift in banks and road soil part. It consists of horizontal probe, bluetooth reel, and the app for smartphone which is required to be downloaded. This product has the ultimate quality of ultra-light, high accuracy, high reliability and high response. The cable reel and a smartphone are linked with each other via bluetooth. The product can be used 40 hours continuously. The app has the functions of saving data, viewing data, and sending an e-mail message.

Model	5481H
Applied sensor	1-MEMS sensor
Measurement range	$\pm 30^\circ$ (vertical)
Resolution	0.005mm / 500mm
System accuracy	± 2 mm / 25m
Data logger	App. based smartphone

26



Digital slope inclined inclinometer

Digital slope inclined inclinometer has 2-MEMS sensor installed at 45° of slope internally. It is used for measuring subsidence or uplift in the slope of dam or in the slope of the stiffener of retaining wall. It consists of slope probe, bluetooth reel, and the app for smartphone which is required to be downloaded. This product has the ultimate quality of ultra-light, high accuracy, high reliability and high response. The cable reel and a smartphone are linked with each other via bluetooth. The product can be used 40 hours continuously. The app has the functions of saving data, viewing data, and sending an e-mail message.

Model	5481T
Applied sensor	2-MEMS sensor
Measurement range	$\pm 30^\circ$ (45° inclined plane)
Resolution	0.005mm / 500mm
System accuracy	± 2 mm / 25m
Data logger	App. based smartphone

27



Spiral sensor probe

Spiral sensor probe is useful to find out matching up between direction of inclinometer casing and direction of measuring. Also, this model can find out the twisting while connection with casing each.

Model	5480P
Applied sensor	Disposable integrated potentiometer
Measurement range	$\pm 10^\circ$
Resolution	$\pm 0.01^\circ$
Accuracy	$\pm 0.5\%$ FSR
Gage length	1000mm

28

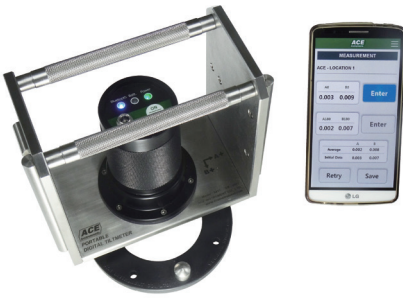

Portable digital tiltmeter

Portable digital tiltmeter is a safety diagnostic measuring instrument for measuring the stability of building structure. It is light and simple with built-in 2-MEMS sensor, data logging circuit, and bluetooth circuit in the tiltmeter. Native app is downloaded and used on smartphone, so data loggers and jumper cables are unnecessary and provide innovative and convenient usability. The digital tiltmeter and smartphone are linked with bluetooth and can use 17 consecutive hours. The operating app has data storage, data viewing, and e-mail sending function.

Model	5411
Applied sensor	2-MEMS sensor
Measurement range	$\pm 30^\circ$
Resolution	0.0005° (2arc seconds)
Accuracy	± 10 arc seconds
Data logger	App. based smartphone

29



ELS tilt sensors

ELS tilt sensor is high precise electrolytic tilt sensor, is attached to the aluminum beam case. Basically, the range of ELS tilt sensor is only $\pm 1^\circ \sim \pm 3^\circ$, but it is possible to spread up to $\pm 4^\circ$ through out adjusting knob after installation.

Model	5440
Applied sensor	ELS sensor (electrolytic level sensor)
Measurement range	$\pm 1^\circ$ $\pm 2^\circ$ $\pm 3^\circ$
Resolution	1arc seconds 2arc seconds 3arc seconds
Accuracy	$\pm 0.1\%$ FSR
Non-linearity	$\pm 0.5\%$ FSR

30



ELS beam sensors

Model 5420 series are designed with ELS tilt sensor put on aluminum pipe which has 1~3m of gage length. These are possible to measure the displacement through out calculation as gage length(L) times tilt and size or outline for subsidence or uplift when it is connected at end of Model 5420.

Model	5420V (vertical)	5420H (horizontal)
Applied sensor	ELS sensor (electrolytic level sensor)	
Measurement range	$\pm 1^\circ$	$\pm 2^\circ$ $\pm 3^\circ$
Resolution	1arc seconds	2arc seconds 3arc seconds
Accuracy	$\pm 0.1\%$ FSR	
Non-linearity	$\pm 0.5\%$ FSR	
Gage length	1 ~ 3m	

31



VW inclinometer

VW inclinometer has superior the reproducibility, responsibility, and resolution because of transmitting the frequency signal, and so quite a precise measurement is possible as being affected by the variation of the temperature. It can precisely measure the size of horizontal, vertical displacement connecting it on the 1~2m length of beam. And especially, it is useful when it is installed on the place that is affected by electrical noise such as subway etc.

Model	1410
Applied sensor	Vibrating wire sensor
Measurement range	$\pm 5^\circ$ $\pm 10^\circ$
Resolution	5arc seconds 10arc seconds
Accuracy	$\pm 0.1\%$ FSR
Non-linearity	$\pm 0.5\%$ FSR

32



MEMS inclinometers

MEMS inclinometer is highly reliable because an amplification circuit is built into the MEMS type inclinometer developed by MEMS technology (micro-electro mechanical engineering technology and micro-reaction technology). It is very useful in sites requiring long-term measurement and in sites requiring automated measurement.

Model	5310 (uniaxial)	5310B (biaxial)
Applied sensor	MEMS sensor (micro electro mechanical system)	
Measurement range	$\pm 5^\circ / \pm 10^\circ$	
Output	-5 ~ +5 VDC	
Accuracy	$\pm 0.1\%$ FSR	
Non-linearity	$\pm 0.5\%$ FSR	

33



WW vertical multi point inclinometers

WW vertical multi point inclinometer is a combination of several WW inclinometers using a wheel assembly and an extension tubes. The advantage of the vibrating wire sensor is that it can be operated unmanned in real time using automated measuring equipment. The gage length is about 1~3m, so it can be installed in uniaxial when the displacement direction is expected. If the displacement direction is not expected it can be installed in biaxial. Model 1430 is precision-processed using a waterproofing capacity of 20bar and a stainless steel anticorrosive material, allowing semi-permanent measurement.

Model	1430U (uniaxial)	1430B (biaxial)
Applied sensor	Vibrating wire sensor	
Measurement range	$\pm 5^\circ / \pm 10^\circ$	
Resolution	5arc seconds / 10arc seconds	
Accuracy	$\pm 0.1\%$ FSR	
Non-linearity	$\pm 0.5\%$ FSR	

34



MEMS vertical, horizontal multi point inclinometer

MEMS vertical, horizontal multi point inclinometer consists of a number of MEMS sensors, guide wheels, extension tubes, and inclinometer casing. Model 4490 is capable of remote measurement or unmanned operation using data logging or automated measurement equipment. This product is made of corrosion-resistant stainless steel for waterproof and rust prevention.

Model	4480
Applied sensor	MEMS sensor
Measurement range	$\pm 10^\circ / \pm 30^\circ$
Resolution	10arc seconds
Accuracy	$\pm 0.1\%$ FSR
Non-linearity	$\pm 0.5\%$ FSR

35



Serial type multi point inclinometers

Serial type multi point inclinometer with built-in serial communication chip uses a method of storing data sequentially by connecting multiple MEMS sensors with a signal cable. Serial type multi point inclinometer is easy to connect to the data logger. Installation in the field is very easy and it is waterproof and rustproof. It is manufactured in vertical and horizontal, uniaxial and biaxial.

Model	4490HS (horizontal uniaxial)	4490MS (vertical uniaxial)	4490BS (vertical biaxial)
Applied sensor	1-MEMS		2-MEMS
Measurement range	$\pm 10^\circ$		
Resolution	10arc seconds		
Accuracy	$\pm 0.1\%$ FSR		
Gage length	Selection of standard length 1, 2, 3m		

36

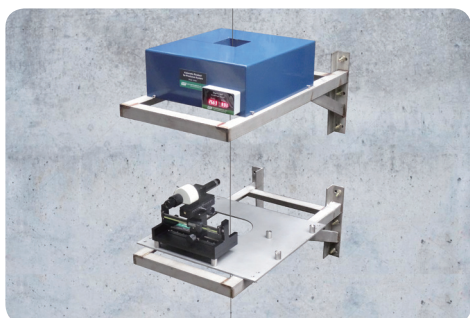

Pendulum system

Pendulum system of Model 8100 can measure the horizontal relative displacement between a dam and rock foundation at a vertical line. After installation of direct or inverted type of pendulum system, it is required to use CCD in order to decide the wire position inside of readout and send measured data to automatic readout.

Model	8100
Applied sensor	CCD (charge coupled device)
Measurement range	$\pm 75\text{mm}$ (manual) / 50mm (automatic)
Resolution	0.01mm
Accuracy	$\pm 0.1\text{mm}$
Components	Inverted pendulum, Direct pendulum, Wire, Portable readout, Automatic readout

37



VV load cells

VV load cell is designed as hollow type for measuring the load being applied to support cable (strand), strut and earth anchor of the structures. We manufacture load cell of up to 1500ton. According to the applied load size, 3-6 pieces of VV strain gage is built in load cell, and it is manufactured into the highly reliable product through the validity verification by the proved universal testing machine.

Model	1102 ~ 1170
Applied sensor	Vibrating wire sensor
Rated capacity	20 ~ 1500ton·f
Resolution	0.025% FSR
Accuracy	±0.1% FSR ~ ±0.5% FSR

38

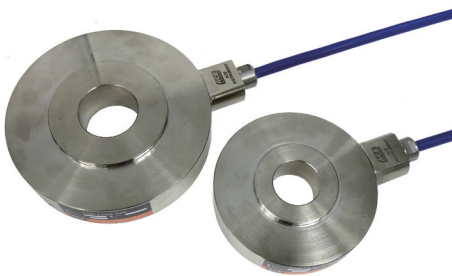

FSG load cells

FSG load cell is designed as hollow type for measuring the load being applied to tie back, rock bolt, earth anchor. We manufacture load cell of up to 1500ton. Even if the eccentric loading is applied to FSG load cells, it independently readout into the automatically compensated value. And it can be used optimally when the pile load test or the dynamic measurement is being required. It is highly reliable product through the validity verification by the proved universal testing machine.

Model	4102 ~ 4170
Applied sensor	FSG sensor (foil strain gage / 8 ~ 16gages)
Rated capacity	20 ~ 1500ton·f
Resistance	700Ω
Rating output	1.5mV/V (1500 x 10 ⁻⁶)
Accuracy	±0.1% FSR ~ ±0.5% FSR

39



Hydraulic load cells

Hydraulic load cell is designed with a structure that allows you to check directly about the size of the changing load in tie back, rock bolt, earth anchor used as support systems. Hydraulic load cell is welded to the outer periphery of two thin, precision-machined stainless steel plates. The inside is filled with oil. Hydraulic load cell has an analog type pressure sensor connected directly to the cell body. The pressure sensor is calibrated in units of load by the effectiveness test of a high-precision load tester(UTM). It is designed in European style, which is optimal for use in the harsh conditions of civil engineering works. In addition, an S type equipped with a VV pressure sensor is manufactured instead of an analog type pressure sensor.

Model	AH50P.R	AH75P.R	AH100P.R	AH150P.R	AH200P.R
Applied sensor	Analog manometer				
Rated capacity	50ton·f	75ton·f	100ton·f	150ton·f	200ton·f
Resolution	2ton·f				
Accuracy	±1.0% FSR				

40



FSG large capacity load cells

FSG large capacity load cell is designed in column type or center hole type and are used for pile load tests or load measurement of high-load structures such as bridges. We manufacture from 500 to 1500ton. Foil strain gage is configured in the shape of a Wheatstone bridge, so even when an eccentric load is applied, a single corrected value is output and dynamic measurement is possible. It is a highly reliable product through the validity verification by an authorized universal testing machine.

Model	4201 ~ 4205
Applied sensor	FSG sensor (foil strain gage / 8 ~ 16gages)
Rated capacity	500 ~ 1500ton·f
Resistance	700Ω
Rating output	1.5mV/V (1500 x 10 ⁻⁶)
Accuracy	±0.1% FSR ~ ±0.5% FSR

41

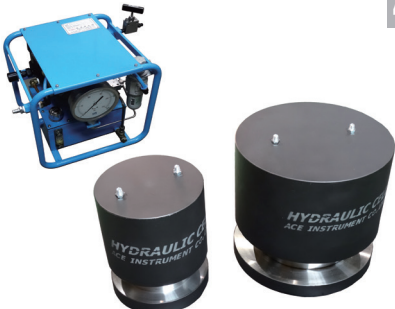

Hydraulic cells for pile load test

We provide Hydraulic cell and pump units which are for pile load test. We provide customized single acting and double acting hydraulic cell which are for 400 ~ 1500ton·f (common pressure 1500bar). Hydraulic cells are including leak tightness preventers and super high pressured airtight design. Also, we take 100% load test for each cell before consignment.

Model	Single acting	Double acting
Working pressure	1500bar	
Load	400, 600, 800, 1000, 1200, 1500ton·f	
Stroke	150mm (optional 100 or 200mm)	
Max. pressure	2000bar	

42

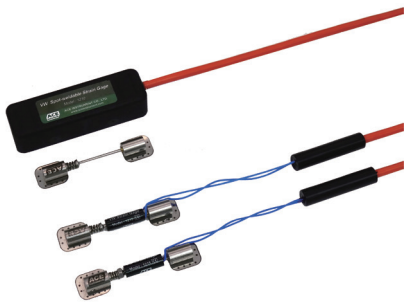

VW spot weldable strain gages

Model 1210 VW spot weldable strain gage is designed as the small size so that it can measure the strain at the steel structure such as bridges, piles, tunnel linings and buildings, after attaching it with spot welding or epoxy. Model 1215 is suitable for tie back, and soil nail as having the small structure that is connected plucking coil on the surface of gage. 1215A and B are possible to measure large range. Model 1215C is manufactured in a structure that can adjust the measuring range.

Model	1210	1215 (mini)	1215A (large range)	1215B (large range)	1215C (adjustable)
Applied sensor	Vibrating wire sensor				
Measurement range	3300microstrain		5000microstrain	10000microstrain	
Resolution	0.5microstrain		1microstrain	2microstrain	
Accuracy	±0.1% FSR				
Non-linearity	±0.5% FSR				

43



VW weldable strain gages

VW weldable strain gage is measuring gages to measure the stress of bridge, building, structure, Model 1220 can measure the stress or strain of the member such as strut, pile. Model 1222 is designed to long gage type product with the length of 250mm. It can measure more exactly when established in the direction of member length(measure of longitudinal strain). Model 1224 is useful if being applied in testing the concrete pile improving steel as manufactured with the structure for high temperature able to be enduring at 200°C. Model 1220A is for large range type.

Model	1220	1222 (long gage)	1224 (high temp.)	1220A (large range)
Applied sensor	Vibrating wire sensor			
Measurement range	3000microstrain			5000microstrain
Resolution	0.5microstrain			1microstrain
Accuracy	±0.1% FSR			
Non-linearity	±0.5% FSR			

44



VW embedment strain gages

Model 1240 VW embedment strain gage is designed to measure strain in reinforced concrete and mass concrete. Short gage length of model 1230 is designed to be useful at tunnel. The model 1230B is useful for measuring strain toward tangential and radial direction tunnel shotcrete. The model 1235 of subminiature size is usefully used when mock-up tested with the gage of 51.5mm or there is the limit on the condition of establishment. The model 1243 is useful if being applicable in testing the concrete pile improving steel as manufactured with the structure for high temperature able to be enduring at 200°C. The model 1245 as the gage with 250mm shows the excellent performance more than normal type model since the seal or compression is great big at the prestressed concrete. Model 1240A is for large range type.

Model	1230 (tunnel)	1230B (mini)	1235 (standard)	1240 (high temp.)	1243 (long gage)	1245 (large range)	1240A (large range)
Applied sensor	Vibrating wire sensor						
Measurement range	3000microstrain						5000microstrain
Resolution	0.5microstrain						
Accuracy	±0.1% FSR						
Non-linearity	±0.5% FSR						

45



FSG strain gages

Model 4240 FSG embedment strain gage is designed to measure the effective displacement precisely that operates inside of concrete structure by laying into reinforced concrete or concrete structure. Specially, it is useful for real time measurement when dynamic measurement is needed for measurement of strain after curing of mass concrete, or for the object of study experiment. Model 4220 FSG surface mount strain gage measures strain by attaching a bracket to the member.

Model	4240 (embedment)	4220 (surface mount)
Applied sensor	FSG sensor (foil strain gage)	
Measurement range	±5000microstrain	
Rating output	1.5mV/V (1500 × 10 ⁻⁶)	
Accuracy	±0.5% FSR	
Resistance	350Ω	

46



VV rebar stressmeters

VV rebar stressmeter is a sensor to measure the stress acting on the deformed rebar of reinforced concrete structures. The diameter of the VV sensor housing is designed in the same shape as the size of the deformed rebar, so accurate measurement is possible. Rebar stressmeter is standard for D25(diameter $\Phi 25.4\text{mm}$) and D32(diameter $\Phi 31.8\text{mm}$), which are applied to most basic civil engineering works. The manufacturing specifications of FSG rebar stressmeter model 4260 and 4290 are the same as the vibrating wire type, but the foil strain gage is applied to the sensor.

Model	1265 (D13)	1260 (D25)	1290 (D32)	4260 (D25)	4290 (D32)
Applied sensor	Vibrating wire sensor			FSG sensor (foil strain gage)	
Measurement range	3000microstrain			$\pm 5000\text{microstrain}$	
Resolution	0.025% FSR				
Accuracy	$\pm 0.1\%$ FSR			$\pm 0.5\%$ FSR	
Non-linearity	$\pm 0.5\%$ FSR			$\pm 1.0\%$ FSR	

47



VV strand strainmeter

VV strand strainmeter is useful for measuring the magnitude, elongation and displacement of the force acting on the strands of an earth anchor, tension and compression anchor. Before shipment, the VV strand strainmeter is individually calibrated by a digital calibrator for the frequency characteristics compared to the amount of displacement(strain rate). The results are recorded in the calibration certificate, ensuring quality and reliability.

Model	1315
Applied sensor	Vibrating wire sensor
Measurement range	30000microstrain
Resolution	0.025% FSR (0.01mm)
Accuracy	$\pm 0.1\%$ FSR
Non-linearity	$\pm 0.5\%$ FSR

48

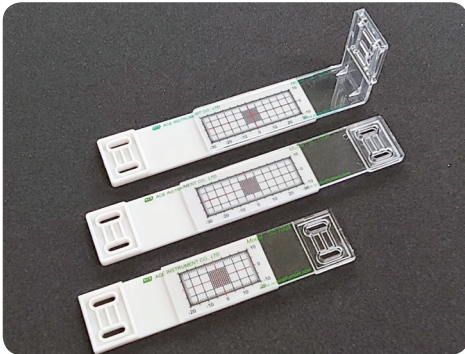

Plastic crackmeters

Plastic crackmeter is an inexpensive crack meter that replaces the sensor. It is suitable for use in the field where high-precision measurement management is not required. Plastic crackmeter is used in sites where continuous crack measurement is required such as cracks in old buildings, roads and walls. Two-dimensional crack measurement is possible with 1 set of plastic crackmeter. Other companies' products are easily broken because they are manufactured by molding acrylic. However, our SC-100 is manufactured by molding polycarbonate resin. It is very hard like metal.

Model	SC-100A	SC-100B	SC-100C
Measurement range	$\pm 20\text{mm}$ (Left, Right), $\pm 10\text{mm}$ (Up, Down)	$\pm 30\text{mm}$ (Left, Right), $\pm 10\text{mm}$ (Up, Down)	$\pm 30\text{mm}$ (Left, Right), $\pm 10\text{mm}$ (Up, Down)
Resolution	1mm (grid type)		
Dimensions	32 x 102 x 5mm (dual)	32 x 132 x 5mm (dual)	32 x 132 x 55mm (dual)
Material	Polycarbonate		

49



VV crackmeters

Model 1330 VV crackmeter is useful for measuring the size change of crack gaps and surface connections of rock or concrete structures. Since there are 4 types of gages with different measuring ranges, they can be selected according to the size of the crack. Model 1322 and 1325 are easy to install as they can be installed using anchors or mounting blocks using quick-setting epoxy. For structures that require precise measurement, it is recommended to use the 1322 with a small measurement range.

Model	1322	1325	1330	1340
Applied sensor	Vibrating wire sensor			
Measurement range	5mm	25mm	50mm	100mm
Resolution	0.025% FSR (0.01mm)			
Accuracy	$\pm 0.1\%$ FSR			
Non-linearity	$\pm 0.5\%$ FSR			

50



WW waterproof crackmeters

WW waterproof crackmeter is an epoch-marking waterproof product which works at 25bar. It is designed with STS316 so that it can measure displacement at dam site which is close or inside of sea site.

Model	1330W	1340W	1341W	1342W
Applied sensor	Vibrating wire sensor			
Measurement range	50mm	100mm	150mm	200mm
Resolution	0.025% FSR			
Accuracy	±0.1% FSR			
Non-linearity	±0.5% FSR			
Waterproof	250mH ₂ O (25bar)			

51

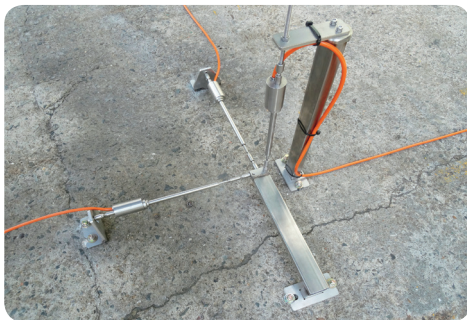

WW 3D jointmeters

WW 3D jointmeter is for 3 axial and it is useful to measure 3-dimensional structure such as concrete dam joint or crack at tunnel and tank. It is designed for waterproof system by STS316 so that it can use at sea site.

Model	1330W-3D	1340W-3D	1341W-3D	1342W-3D
Applied sensor	Vibrating wire sensor			
Measurement range	50mm	100mm	150mm	200mm
Resolution	0.025% FSR			
Accuracy	±0.1% FSR			
Components	Standard mount bracket, sensor bracket, anchor bolt			
Material	STS304, STS316(L) for sea side			

52



WW compression displacement sensors

WW compression displacement sensor is designed to measure displacement of straight. The spring is applied at end of WW compression displacement sensor and it allows to measure up to 0.01mm at pile load test and crack.

Model	1325C	1330C	1340C
Applied sensor	Vibrating wire sensor		
Measurement range	25mm	50mm	100mm
Resolution	0.25% FSR (0.01 ~ 0.02mm)		
Accuracy	±0.1% FSR		
Non-linearity	±0.5% FSR		

53



FSG crackmeters

FSG crackmeter is composed of sensor part and anchor fixed part. Anchor should be fixed by anchor bolt or grouting in the both ends of crack across the crack. Model 4330, 4331 FSG type crackmeter is provided with calibration record by sensors, by digital calibrator it correct electric resistance feature in proportion to displacement. Therefore It guarantees confidence and reproducibility.

Model	4330	4331
Applied sensor	FSG sensor (foil strain gage)	
Measurement range	5mm	10mm
Rating output	6mV/V (6000 × 10 ⁻⁶)	25mm
Accuracy	±0.5% FSR	
Resistance	350Ω	

54



Mechanical 3D jointmeters

Mechanical 3D jointmeter is measuring kit for 3 axial and it is useful to measure 3-dimensional structure such as dam site by dial gauge.

Model	6310		
Measurement range	±12.5mm	±25mm	±50mm
Resolution	0.01mm		
Material	SM45C steel (Standard), STS316(L) for sea site		

55



VW soil strainmeters

Model 1360 VW soil strainmeter can measure the size, ratio, and tendency of the underground displacement acting on the slope due to freshwater pressure by embedding multiple stations for each station at various measuring points of the embankment dam. Underground displacement can be measured at embankment or road embankment.

Model 4360 Electrical soil strainmeter has a built-in potentiometer. The basic structure and use are the same as the VW soil strainmeter.

Model	1360	4360
Applied sensor	Vibrating wire sensor	Potentiometer
Measurement range	150mm 300mm	100~300mm
Resolution	0.03mm 0.06mm	Infinite
Accuracy	±0.1% FSR	
Non-linearity	±0.5% FSR	

56



VW jointmeters

Model 1310 VW surface mount jointmeter can easily measure the joints of concrete dams, tunnels, tanks, bridge piers, joint of abutments, crack size and progression of structures using mounting brackets. It is designed with a durable structure. The model 1320 VW embedment jointmeter is used with embedment accessories. It can be installed on the inner joint of concrete structures such as dams, embankment foundations, and bridges to measure the magnitude and speed of displacement. Model 1310 is divided into uniaxial and triaxial. This sensor consists of a main body, mounting bracket and anchor kit which are accessories for installation. Model 1320 consists of a body for installation inside concrete, a sensor socket and a target which are accessories for installation.

Model	1310 (surface mount type)	1320 (embedment type)
Applied sensor	Vibrating wire sensor	
Measurement range	50 ~ 200mm	
Resolution	0.01 ~ 0.04mm	
Accuracy	±0.1% FSR	
Non-linearity	±0.5% FSR	

57



Electrical jointmeter

Electrical jointmeter measures the magnitude and trend of displacement in dams, bridge piers and abutments. For accurate measurement, this model uses high-accurate potentiometer and it shows voltage(mV) under every different displacement by working site.

Model	4315
Applied sensor	Potentiometer
Measurement range	25 ~ 150mm
Resolution	Infinite
Accuracy	±0.1% FSR
Non-linearity	±0.5% FSR

58



Long range crackmeter

Long range crackmeter has wire to rotary potentiometer that can measure maximum 3m. It can measure displacement that can occur greatly in wall of apartment if is rock slope or cut off wall precisely.

Model	5900
Applied sensor	Rotary potentiometer
Measurement range	0.5, 1, 2, 3m
Rating output	1kΩ
Resolution	Infinite
Accuracy	±0.1% FSR
Non-linearity	±0.5% FSR

59



VW settlement gage

VW settlement gage that have VW sensor can measure settlement or heave of construction site. VW settlement gage is consisted of liquid reservoir kit, tube that liquid fills and VW pressure sensor and automation measure is available and long distance transmission of output signal is available.

Model	1810
Applied sensor	Vibrating wire sensor
Measurement range	0.7 ~ 2.0kg/cm ²
Resolution	0.5 ~ 4.0mm
Accuracy	±0.1% FSR
Non-linearity	±0.5% FSR

60

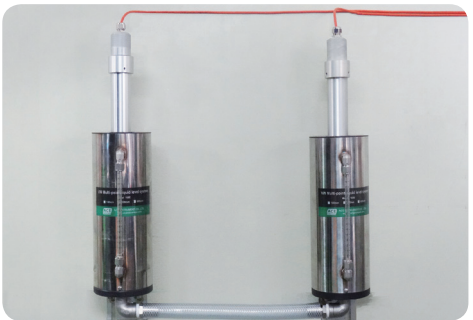

High sensitivity settlement systems

Model 1680 VW high sensitivity settlement system can precisely measure the finest deflections of abutments or piers. It consists of a water tank and a monitoring vessel. The model 1680 VW high sensitivity settlement system has a wide measurement range compared to the electric system and allows semi-permanent measurement. Model 4660 electric system is similar to the Model 1680. The LVDT or high-precision potentiometer is directly built-in inside the monitoring vessel, so the sensor directly detects the position change of the buoy. It can detect fine vertical displacement of 0.01mm. Model 5680 ultrasonic system is the same voltage(mV) output method as Model 4660. Ultrasonic is used to measure micro-displacement in a non-contact method.

Model	1680	4660	5680
Applied sensor	Vibrating wire sensor	LVDT or potentiometer	Ultrasonic sensor
Measurement range	100mm 300mm 600mm	100mm (optional 50mm)	100mm (optional 200mm)
Resolution	0.01mm 0.03mm 0.06mm	0.01mm (infinite)	0.01mm (infinite)
Accuracy	±0.1% FSR		
Non-linearity	±0.5% FSR		

61

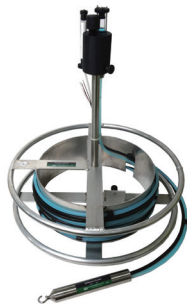

Settlement profiler

Settlement profiler can measure the settlement and heave at bank, LPG or LNG tank, road, etc. There is a semiconductor sensor inside of probe and liquid tube is coiled at reel.

Model	5200
Applied sensor	Semiconductor pressure sensor
Measurement range	10m
Resolution	0.01% FSR
Accuracy	0.1% FSR
Dimensions	∅35 x 200mm (probe) / ∅600 x 200mm (wheel)

62



Current type extensometer

Current type extensometer is used to monitor settlement in excavations, dams, and embankments by accessing inside of inclinometer casing.

Model	5600
Applied sensor	Current type
Measurement range	50m
Resolution	1mm
Weight	2.5kg
Dimensions	∅42mm (probe) / 152(W) x 278(L) x 282(H)mm (wheel)
Using temperature	0 ~ 40°C

63

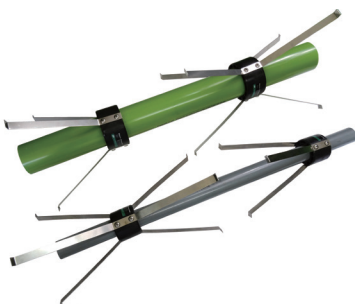

Magnetic sensors

Magnetic extensometer measures settlement or heave in fills, foundations and dams. Magnetic extensometer consists of sensing rings, a magnetic indicator, an access pipe, telescopic sections and an end is anchored in stable ground, the depth of each sensing ring is referenced to a datum ring that is fixed to the bottom of the access pipe. The sensing rings include plate rings, spider rings and datum ring.

		4680P	4680C
Sensing ring	Datum ring	To install at stable ground	for O.D ∅38mm
	Spider ring	To install several pieces at each stratum	PVC pipe (∅26 ~ ∅64mm O.D optional)
	Plate ring	To install at embankment	for O.D ∅70mm, ∅85mm inclinometer casings

64

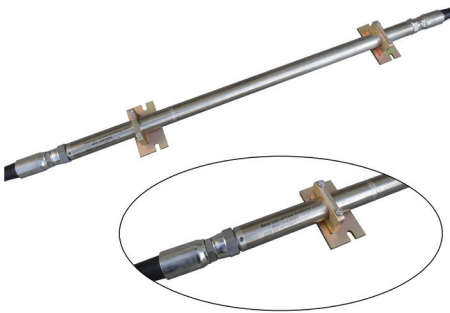

Rail track monitoring system

ACE-RTM Rail track monitoring system can accurately measure the settlement or twist of the rail on the railroad. Rail track monitoring system can easily measure the size or tendency of the settlement and twist of the rail when urban construction is underway adjacent to the railroad, or underground passageway or subway tunnel construction is underway. The sensor is built into a waterproofed stainless tube and is connected to the joint and the protective tube with a serial communication one-line cable. It is very easy to install in the field as it comes pre-assembled with multiple points of sensors.

Model	ACE-RTM-U (uniaxial)	ACE-RTM-B (biaxial)
Applied sensor	MEMS sensor	
Measurement range	$\pm 10^\circ$	
Resolution	10arc seconds	
Accuracy	$\pm 0.1\%$ FSR	
Non-linearity	$\pm 0.5\%$ FSR	
Communication method	Serial communication (One-line)	

65



USBR type settlement probe

USBR type settlement probe is designed to measure ground settlement and heave. Also, it is useful for accuracy elevation of inclinometer data.

Model	5010SP
Applied range	Inclinometer casing (ID : $\phi 50 \sim \phi 73\text{mm}$) which is applied telescopic section
Weight	3.3kg
Dimensions	$\phi 40 \times 600\text{mm}$

66

Wire sensor type extensometer

Wire sensor type extensometer is consisted of wire displacement sensor for installation point, grouting anchor at foundation rock inside of borehole for fixing. It is also consisted of stainless wire and protective tube for connecting between wire displacement sensor and grouting anchor. Wire sensor has rotary type of potentiometer inside for high precision. It is optimized to measure accurate data and wide range(3000mm).

Model	4750
Applied sensor	Rotary potentiometer
Measurement range	500 ~ 3000mm
Resolution	Infinite
Accuracy	$\pm 0.1\%$ FSR
Non-linearity	$\pm 0.5\%$ FSR

67

VW borehole rod extensometers / MPBX

Model 1380 VW borehole rod extensometer is designed to measure the displacement of each stratum due to the settlement of boreholes or elevations by 1-6 measuring anchors at the reference point of the ground. It is composed of anchor, rod, protection tube and sensor part. The sensor part is equipped with a precise VW displacement sensor. There are two types of VW extensometer, 50mm and 100mm, so it can be selected according to the size of the expected displacement. Unmanned automated measurement and long-distance transmission of output signals are possible. Model 4380 FSG borehole rod extensometer has the same basic structure as the vibrating wire equation. The sensor has a built-in FSG sensor.

Model	1380	4380
Applied sensor	Vibrating wire sensor	FSG sensor (foil strain gage)
Measurement range	50mm	100mm
Resolution	0.01mm	0.02mm
Accuracy	$\pm 0.1\%$ FSR	$\pm 0.5\%$ FSR
Non-linearity	$\pm 0.5\%$ FSR	$\pm 1.0\%$ FSR
Measuring point	Standard : 1 ~ 6 points	

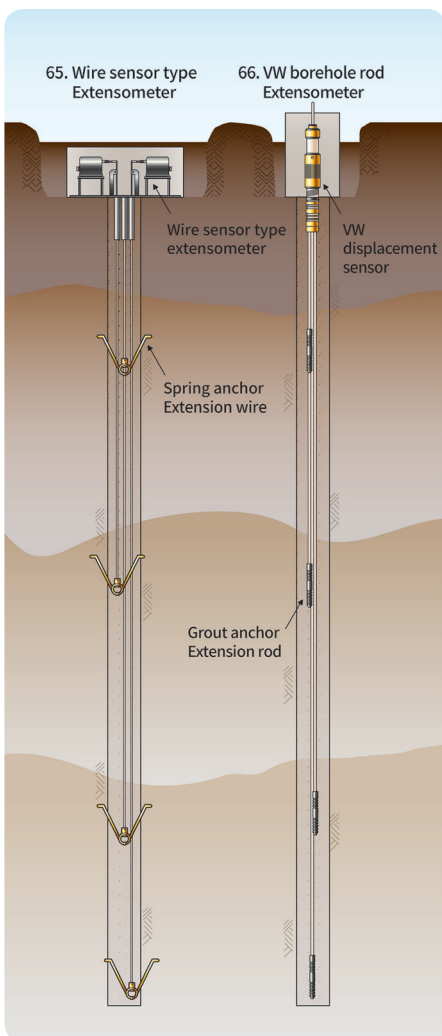

68



VV piezometers

VV piezometers are designed to measure pore water and fluid pressure. Model 1510 VV piezometer is designed to be embedded in earth fills and at concrete interfaces or inserted into boreholes and small diameter pipes. Model 1515 is designed for low pressure and Model 1500S and 1500US are for subminiature. Model 1520 available for pushing directly into soft ground. Model 1530 is designed to measure fluid pressure in pipelines for industrial and hydraulic. And it is useful to measure upstream pressure in a hydroelectric power plant. Model 1540 available for heavy duty. This model is specially manufactured to use in the site where semi permanent measurement is necessary like dam site. Model 1545 is equipped with a ring type large metal filter. The ring type filter has a very wide contact surface and can be used for all part such as seawater, sand layer, sediment layer, mineral layer. It can use as water level sensor as well.

Model	1510 (standard)	1515 (low pressure)	1520 (push in)	1530 (pressure sensor)	1540 (heavy duty)	1545 (ring filter)	1500S (slim size)	1500US (ultra slim)
Applied sensor	Vibrating wire sensor							
Measurement range	2 ~ 70kg/cm ²							
Resolution	0.025% FSR							
Accuracy	±0.1% FSR							
Non-linearity	±0.5% FSR							

69



VV multi point piezometer

VV multi point piezometer can measure drilling hole internal stratification pore water pressure because it consisted of 1510 VV piezometer and PVC extension tube, housing to attach piezometer. This product can cope water leakage problem that appear when install several piezometer to 1 drilling hole and install is simple.

Model	1500
Applied sensor	Vibrating wire sensor
Measurement range	2 ~ 70kg/cm ²
Resolution	0.025% FSR
Accuracy	±0.1% FSR
Non-linearity	±0.5% FSR

70



VV vented piezometer

VV vented piezometer is useful at detailed survey time that atmospheric pressure revision unnecessary and thin having atmospheric pressure tube to signal cable. This product is useful to water level measurement of lake, river.

Model	1560
Applied sensor	Vibrating wire sensor
Measurement range	2 ~ 70kg/cm ²
Resolution	0.025% FSR
Accuracy	±0.1% FSR
Non-linearity	±0.5% FSR

71



FSG/Semiconductor piezometers

Model 4510 FSG piezometer is designed to measure pressure vessel or pipeline, embankment and pore water pressure and so on. Specially, because dynamic measure suitable in study purpose or spot that need real time measure. Model 4510 is designed to lay under the ground directly on embankment or foundation. Model 4515 semiconductor piezometer is very useful measure to low pressure.

Model	4510	4515
Applied sensor	FSG sensor (foil strain gage)	Semiconductor pressure sensor
Measurement range	2 ~ 35kg/cm ²	1 ~ 20kg/cm ²
Rating output	1mV/V (1000 × 10 ⁻⁶)	4 ~ 20mA 2wire or 1 ~ 5V
Accuracy	±0.5% FSR	
Resistance	350Ω	

72



Lab. instruments

Model 4530 miniature piezometer and model 4950 miniature earth pressure cell are very useful products when model experiments are required in civil engineering departments of universities or national research institutes. This product has a built-in electric sensor with a foil strain gage attached with high accuracy and high reliability and is waterproof and anticorrosive. The dynamic measurement and long-distance transmission are available.

Model	4530 (miniature piezometer)	4950 (miniature earth pressure cell)
Applied sensor	FSG sensor (foil strain gage)	
Measurement range	1 ~ 10kg/cm ²	
Rating output	1mV/V (1000 x 10 ⁻⁶)	
Accuracy	±0.5% FSR	
Resistance	350Ω	

73



Pneumatic piezometer

Pneumatic piezometer is a mechanical piezometer. Measure by reading the offset pressure balance of the nitrogen gas pressure and water pressure emitted from the pneumatic sensor indicator. It is high reliability with low price for excellent accuracy. It is designed to measure the water pressure and pore water pressure about borehole, foundation, embankment.

Model	2510
Applied sensor	Pneumatic sensor
Measurement range	0 ~ 15kg/cm ²
Resolution	0.001kg/cm ²
Accuracy	±0.5% FSR

74



VW weir monitoring system

VW weir monitoring system employs a VW transducer and is sensitive to water level. This consists of the VW transducer, a cylindrical buoy assembly to detect water level, and a chamber to inject water. Water level in a chamber serves as buoyancy that is equal to adjacent water level. When using it under weir monitoring system on the dam site. You have to apply them to accessories on V notch, wave filter and discharge weir and the size or installing place has to be consulted beforehand.

Model	1650
Applied sensor	Vibrating wire sensor
Measurement range	300mm, 600mm, 1500mm
Resolution	0.025% FSR
Accuracy	±0.1% FSR
Non-linearity	±0.5% FSR

75



Standpipe piezometer

Standpipe piezometer is useful to receive precious data instead of using electrical transducer. It consists of a reel frame with a buzzer and a light, a graduated 50m~500m tapes and a probe. For use this to piezometer, after the filter tip and standpipe are installed borehole, it should be covered the around filter tip with sand. The top of the filter zone is sealed with bentonite to isolates the pore water at the tip. The upper bentonite zone is back filled to the surface with a bentonite grout to prevent vertical migration of water.

Model	4650	
Water level meter	Range	50 ~ 500m
	Tape resolution	1mm
	Weight	2.5 ~ 15kg
Filter tip	Density / Material	50μm / PE or ceramic filter
	Dimensions	φ39 x 390mm

76

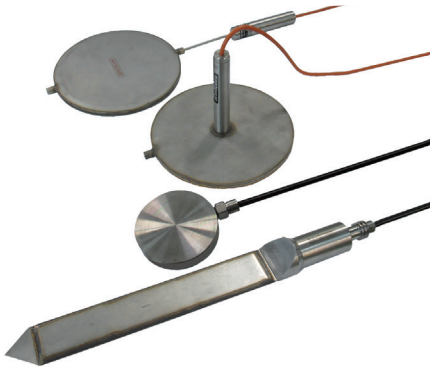

VW earth pressure cells

VW earth pressure cell is used to verify the excessive pressure of the structure or design assumptions. Model 1910(standard) is used to measure the total pressure applied to the dike, embankment, alternation of buildings, bridges and sheet piles. It is very useful to install 3~5 sets in one group in a dam or embankment. Model 1920(jack out) is designed to measure the total pressure acting on a retaining wall or slurry wall. This sensor must be used with a hydraulic jack, a bearing plate and a reaction plate. Model 1930(with built-in strain gage) has a VW strain gage built into the cell and is useful for tunnel lining or model experiments at an affordable price. Model 1940(push in) is designed in a long and thin shape to measure the lateral pressure of the hole or to be mounted at the boring drill for soil testing. The circular cell size of model 1910, 1920 are $\Phi 230\text{mm}$ and model 1911, 1921 are $\Phi 150\text{mm}$ as small size.

Model	1910 (standard)	1911	1920 (jack out)	1921	1940 (push in)	1930 (VW strain gage)
Applied sensor	Vibrating wire sensor					
Measurement range	2 ~ 70kg/cm ²					20kg/cm ²
Resolution	0.025% FSR					
Accuracy	$\pm 0.1\%$ FSR					$\pm 0.5\%$ FSR
Non-linearity	$\pm 0.5\%$ FSR					$\pm 1.0\%$ FSR

77



FSG earth pressure cells

FSG earth pressure cells are useful on real-time measure when dynamic measure does requisitely in examination construction of censure consolidation special quality or study purpose. Model 4910 uses to measure total pressure acting to embankment, building, abutment of bridge and sheet pile by standard type(O.D : $\Phi 230\text{mm}$). Model 4920 is designed to measure total pressure on retaining wall or slurry wall by jack out type(O.D : $\Phi 230\text{mm}$). Model 4930 and model 4940 O.D $\Phi 100\text{mm}$ in dynamic measure such as limitation of establishment place and scale model test as useful.

Model	4910	4920	4930	4940
Applied sensor	FSG sensor (foil strain gage)			
Measurement range	2 ~ 50kg/cm ²			
Rating output	1mV/V (1000 x 10 ⁻⁶)			
Accuracy	$\pm 0.5\%$ FSR			
Resistance	350 Ω			

78



Temperature gages

Model 1010 VW temperature gage consists of the stainless steel transducer body to which a VW sensor element is attached. The frequency signal from VW temperature gage is very stable and accurate. Automatic measuring is possible. Moreover, VW temperature gage is possible to measuring in semi-permanent, and it is manufactured in the structure of waterproof. Model 5550 Thermistor probe or RTD is the temperature gage that thermistor is built in it, it is useful for measuring the long range of temperature, and short period.

Model	1010	5550
Applied sensor	Vibrating wire sensor	Thermistor or RTD
Measurement range	-40 ~ 150 $^{\circ}\text{C}$	-30 ~ 120 $^{\circ}\text{C}$
Resolution	0.03 $^{\circ}\text{C}$	0.1 $^{\circ}\text{C}$
Accuracy	$\pm 0.1^{\circ}\text{C}$	$\pm 0.5^{\circ}\text{C}$
Non-linearity	$\pm 0.5\%$ FSR	

79



Multi point temperature gage

Multi point temperature gage is developed in the way of connecting multiple thermistors in each position of multi cable and applying plastic-finishing to its outside for waterproof. Multi point temperature gage is designed for measuring the curing temperature of each position in concrete dam or large-cast concrete.

Model	5560
Applied sensor	Thermistor
Measurement range	-30 ~ 80 $^{\circ}\text{C}$
Resolution	0.1 $^{\circ}\text{C}$
Accuracy	$\pm 0.5^{\circ}\text{C}$

80



Digital tape extensometer

Digital tape extensometer is a measuring instrument that measures small relative displacement by connecting two points with steel tape. It is useful to measure the size of deformation when excavating underground space. It consists of a steel tape and a high-precision digital gauge in the housing, a tension adjustment sleeve, and a moving hook that can move during tension adjustment. It is made with a slider cover for easy on/off.

Model	2350D
Applied sensor	Digital gauge (Mitutoyo's, Japan)
Measurement range	Standard 20m, Optional 30m
Resolution	0.01mm
Accuracy	±0.1mm

81



VW convergence meters

Model 1345 VW convergence meter is mainly used to understand any changes in size, ratio and tendency of tunnel, caused by constructing tunnels or underground structures. Convergence meter is composed of sensor part, stainless steel extension rod and hook. It is a precise instrument, which measure inner section between 2 points by placing hooks at both sides' ends.

Model	1345	1346
Applied sensor	Vibrating wire sensor	
Measurement range	0 ~ 50mm	0 ~ 100mm
Resolution	0.01mm	0.02mm
Accuracy	±0.1% FSR	
Non-linearity	±0.5% FSR	

82



Rock bolt pull tester set

Model 7200 Rock bolt pull tester set is a portable product operated to verify the eligibility and effectiveness of rock bolts installed to reinforce rock mass in tunnels or slopes. It is useful for judging the proper length of the rock bolt and determining the fixing method and type of the rock bolt. Model 7201 Digital rebar pull tester set is used to verify the fixing power and effectiveness of the constructed rebar. You can easily check the load applied to the reinforcing bar with digital numbers in tons.

Model	7200	7201
Portable pump	Max. pressure : 700kg/cm ² / Weight : 10.9kg	
Pressure meter, Indicator	Analog sensor 700bar (34ton)	Digital sensor 700bar (60ton)
Hydraulic hose	Sheath : neoprene rubber / Dimensions : φ13 x 15mm	
Cylinder (RAM)	Portable / Hollowness type Stroke : 63mm	Portable / Hollowness type Stroke : 50mm
Magnetic stand & gage	Dial gauge / Resolution : 0.01mm (Optional : Digital gauge)	

83



Geodetic targets

Model 7500 Reflection target is a total station for civil engineering works such as tunnel or excavating underground. There are a triple prism and bi-reflection target for a total station. It uses high brightness for displacement and thus its accuracy is lower than triple prism and its range of force is up to 100m. As it allows for 2-dimensional measurement, it is very handy for civil engineering works such as tunnel and its price is very low compared to prism. Model 7510 Triple prism has high brightness because of using reflection of light and its range of force is up to 500m. Also, it is possible to use for 3-dimensional measurement.

Model	7500 (bi-reflection target)	7510 (prism target)
Accuracy	Angle ±0.5mgon, distance ±1.2mm	Angle ±0.3mgon, distance ±1.0mm
Weight	0.1kg	0.2kg
Material	Nylon #66 + G.F 50%	
Target grade	High bright reflection sheet	Crystal prism

84



Tunnel convergence monitoring system

ACE-TCS Tunnel convergence monitoring system is used for detecting the size and direction of the deformed cutting plane in tunnel or underground structure. For a single track tunnel, 8~10 displacement sensors and tilt sensors are installed; for a double track tunnel, 14~16 are installed along the tunnel wall. ACE-TCS has vibrating wire displacement sensor and MEMS tilt sensor built in. It can easily be installed, enduring the measured data with high precision. When the analysis program 'TCS-PRO' is used, 2D graphics are displayed in the unit of 0.01mm.

Model	ACE-TCS	
Applied sensor	VW displacement sensor	MEMS tilt sensor
Measurement range	20mm	±5°
Resolution	0.005mm	5arc seconds
Accuracy	±0.1% FSR	
Non-linearity	±0.5% FSR	

85

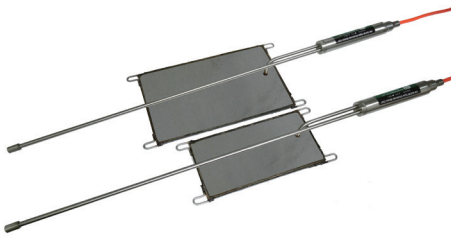

VW NATM shotcrete stress cells

VW NATM shotcrete stress cells are designed according to NATM recommended method to measure radial and tangential stresses of tunnel shotcrete lining. This sensor is often combined with a tape extensometer, VW rod extensometer, and VW rockbolt stressmeter to measure the magnitude and direction of force acting on the lining, and is useful for determining the thickness of the lining and the timing of the secondary pour.

Model	1270	1280
Applied sensor	Vibrating wire sensor	
Application	Tangential cell	Radial cell
Measurement range	70, 200kg/cm ²	30, 50kg/cm ²
Resolution	0.025% FSR	
Accuracy	±0.1% FSR	
Non-linearity	±0.5% FSR	

86



Mechanical extensometers

Mechanical extensometer is measured by using a depth gauge. Model 2390 is shipped assembled at the factory to measure 6m. In case of Model 2391A, the anchor rod is made of fiberglass and is rolled up and shipped. It is useful for excavation work in tunnels, mines, communication ports, common areas and underground spaces.

Model	2390	2391A	2391B
Measuring method	Dial depth gauge		
Measuring point	4P	1 ~ 4P	1 ~ 6P
Measurement range	50mm(standard), 100mm(Optional)		
Full length	2 ~ 6m	Over 7m	

87

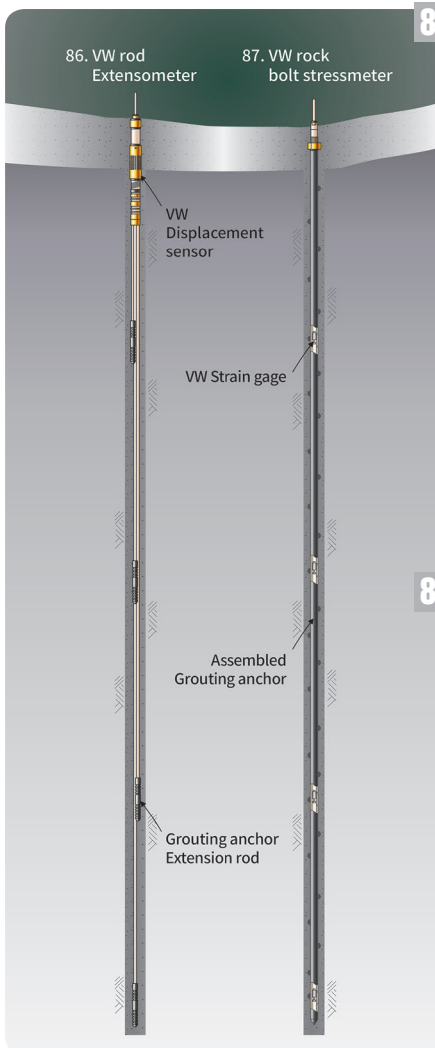

VW rod extensometers / MPBX

VW rod extensometer is useful for measuring the displacement of the surrounding ground due to convergence, the deformation of the slope, and the vertical and horizontal displacement of soil or rock in the tunnel when excavating underground spaces such as tunnels, mines, hangars, communication ports and common areas. Model 1390 VW rod extensometer consists of a built-in sensor part and anchor rod with 4 small VW displacement sensors waterproof and moisture-proof. Model 1390's anchor length is divided into 2-6m length, so it can be selected according to the design specified length or construction site situation. Model 1391 is designed to be assembled and installed in the field with an anchor of 7m or more. Model 4390 FSG rod extensometer has the same structure as VW type. The sensor has a built-in FSG type displacement sensor.

모델	1390 (standard)	1391 (ass'y on site)	4390
Applied sensor	Vibrating wire sensor		FSG sensor (foil strain gage)
Measurement range	50mm, 100mm, 200mm		
Resolution	0.01mm		
Accuracy	±0.1% FSR		
Non-linearity	±0.5% FSR		

88

VW rock bolt stressmeters

Model 1350 VW rock bolt stressmeter is used to verify validity such as effective length, quantity and stress of rock bolts. It is also equipped with four VW strain gages, each other equally spaced in the rock bolt, and is waterproof and anticorrosive. VW rock bolt stressmeter employs typically four measuring points that is equivalent to layers. FSG sensor is used in model 4350.

Model	1350	4350
Applied sensor	Vibrating wire sensor	FSG sensor (foil strain gage)
Measurement range	3300microstrain	
Resolution	1.0microstrain	
Accuracy	±0.1% FSR	
Non-linearity	±0.5% FSR	

89

VW borehole rock stressmeters

Model 1338 VW borehole rock stressmeter is a rock stressmeter using a vibrating wire sensor to measure the deformation of a borehole. It is designed to measure the change in stress of rock mass in tunnels and mines for a long time.

Model	1338EX	1338BX	1338NX
Applied sensor	Vibrating wire sensor		
Borehole diameter	Ø37 ~ Ø39mm	Ø58 ~ Ø61mm	Ø74 ~ Ø77mm
Measurement range	700kg/cm ² (70MPa) compression / 30kg/cm ² (3MPa) tension		
Resolution	0.014 ~ 0.07kg/cm ² (14 ~ 70kPa)		
Accuracy	±0.1% FSR		

90

VW soft inclusion stress cells

VW soft inclusion stress cell(SISC) can be installed in HQ, PQ, and 6-inch large diameter diamond boreholes. SISC consists of a body part with a built-in vibrating wire and coil in a round-circular housing, a wedge part for applying a load, and a bearing plate for receiving a load. This product must apply the modulus of elasticity of the rock mass previously sampled. VW SISC has built-in high-accuracy resistance temperature sensor to compensate for the coefficient of linear expansion of the gage due to temperature change, and is waterproof and rust-proof, so semi-permanent measurement is possible.

Model	1370HQ	1370PQ	1370H	1370M
Applied sensor	Vibrating wire sensor			
Borehole diameter	Ø93mm HQ	Ø123mm PQ	Ø152mm (6inch)	Ø152mm (6inch)
Installation method	Hydraulic type		Mechanical	
Measurement range	±35MPa (±350kg/cm ²)			
Accuracy	±0.1% FSR			

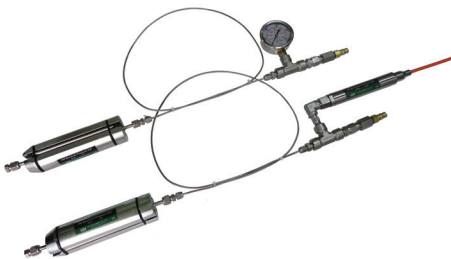
91

VW borehole pressure cell

VW borehole pressure cell is designed for high-accuracy measurement of rock stress. This product is usefully used in rock structures such as mines, nuclear defense plants and hydroelectric power plants. During operation, the initial load must be applied by the hydraulic system after the cell part is inserted into the hole.

Model	1339	1339A
Applied sensor	Vibrating wire sensor	Analog manometer
Measurement range	20, 35, 70MPa	
Resolution	0.25% FSR	0.5% FSR
Accuracy	±0.1% FSR	±0.5% FSR
Non-linearity	±0.5% FSR	±1.0% FSR

92

VW biaxial stressmeter

VW biaxial stressmeter is designed to measure the change of the rock(BX drill hole-Ø60mm) stress. Stressmeter has 3nos VW strain gages in the direction 60°, so you can know direction and size of rock stress.

Model	1375
Applied sensor	Vibrating wire sensor
Measurement range	70MPa
Resolution	14 ~ 70kPa
Accuracy	±0.1% FSR
Non-linearity	±0.5% FSR

93



3D rock borehole deformation gage & data logger

3D rock borehole deformation gage & data logger use overcoring technique to measure the deformation modulus of rock. This equipment is commercialized for the first time in the world with the use of the patent of researchers of Korea Institute of Geoscience and Mineral Resources. The product consists of the sensor part with built-in 4-rosette type strain gage and epoxy actuator at the time of overcoring and the logger part with data logger and compressed air tank, ensuring high reliability, high precision, and engineering-friendliness. The cutting-edge equipment supports the separation of the data logger after test and the installation to PC program for analysis.

The sensor part is disposed of after one-time use. The data logger is collected together with installation tools, and can be used almost semi-permanently. With the use of PC program, it is possible to check the analysis results easily.

Model	4336P (sensor part)	4336D (data logger part)
Applied sensor	3D-FSG sensor	3D-FSG sensor reading, storage
Resistance	120Ω	
Accuracy	±0.5% FSR	
Borehole diameter	∅38mm(EX diamond drill)	
Overcoring depth	Min 1.0m ~ max 15m	
Material	Stainless steel	

94



FSG borehole deformation gage

2D borehole deformation gage is an equipment that measure stress of base rock at overcoring of base rock as in-situ test equipment. If is pressed down within hole because plunger that can detect base rock strain or 3 directions to model 4338 install after the first EX drill hole and transfers by out device. Model 4338 is designed so that fine setting may be available in base rock boring in tunnel, nuclear plant construction, hydroelectric power plant construction etc.

Model	4338
Applied sensor	FSG sensor (foil strain gage)
Borehole diameter	∅38mm(EX diamond drill)
Resolution	0.1microstrain
Overcoring depth	Min 1.0m ~ max 15m
Accuracy	±0.5% FSR

95



Rock borehole pressuremeter

GJ-75 rock borehole pressuremeter is attached bearing plate of jack to measure the contraction and expansion for the displacement of borehole wall pressured by a hollow wall.

This jack is located in appointed location of hole connected such as drill rod of NX boring machine for hydraulic lines and signal cable. When applied hydraulic to manual hand pump, the jack's bearing plate will expansion and the borehole will attached to borehole wall. Jack has 2 LVDT to measure the displacement deviation of rock. Display readout(GJ-75R) for displacement sensor connected to signal cable.

Model	GJ-75H (hard rock)	GJ-75S (soft rock)
Applied sensor	LVDT(2.5mm) 2 nos	
Piston quantity	12 nos	3 nos
Borehole diameter	∅70 ~ ∅85mm	
Components	Readout : GJ-75R Hand pump : GJ-75P Hydraulic hose : 15m	Soft rock jack Hard rock jack Signal cable : 15m

96



Borehole pressuremeter

PMT-75 borehole pressuremeter(PMT) is the lateral load testing equipment of borehole whose pressure capacity is 20MPa. This equipment targets hard soil layers that can't be measured with the LLT test equipment and can measure from soft ground to hard ground(weathered rock layer).

Model	PMT-75
Borehole diameter	∅77 ~ ∅97mm (20mm)
Applied sensor	Measuring displacement of diameter : LVDT Measuring inside of water pressure : water pressure sensor
Components	Readout : PMT-75R Pressuremeter probe : PMT-75 Hand pump : PMT-75P
	Hyd. hose Signal cable Testing jig

97

Borehole shear tester

BST-75 borehole shear tester is designed for measuring shear resistance at $\varnothing 75\text{mm}$ size of borehole inside so that it can provide adhesive power and frictional angle. It is possible to take a test at several point of inside of borehole.

Model	BST-75
Test standard	$\varnothing 70 \times 52\text{mm}$ / Max. pressure : 1.0MPa
Max. authorized pressure	1.0MPa
Components	Readout Tester head set Extension rod, Hyd. hose, Foot pump

98

Portable spot welder

ACE-1200 portable spot welder is designed to use the VW spot weldable strain gage more conveniently on the site. It charges with electricity 100% by SCR condenser. It also offers you highly precise and qualified welding effect. As its welding time is short, the deformation by heat and deformation of welding electrode are minimal. Therefore, it is easy for even beginners to work with less restriction on welding and working condition. Also it is designed as a compact size to maximize its portability.

Model	ACE - 1200
Input	220VAC / 4.5KVA
Welding capacity	Max. 0.8t
Controller	SCR condenser
Dimensions	320 x 190 x 190mm
Weight	25kg

99

Sealing kits

When connecting the signal cables to extend, the Sealing kit is a product that makes the connecting part being connected even better than the original state of signal cables.

Sealing kits are prepared in wide variety for $\varnothing 3 \sim \varnothing 12\text{mm}$.

Model	K - A, B, C
Size of applied cable	A type : $\varnothing 3 \sim \varnothing 7\text{mm}$ B type : $\varnothing 5 \sim \varnothing 10\text{mm}$ C type : $\varnothing 8 \sim \varnothing 14\text{mm}$
Material	PVC & PE
Using epoxy	Rapid epoxy for liquid type

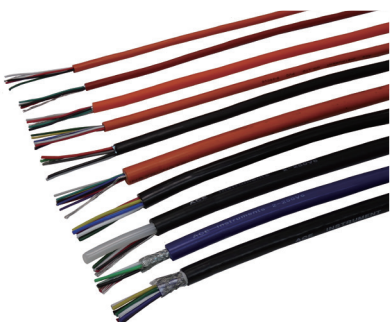
100

Signal cables

Signal cables are made to various quality of the material and diameter to apply in engineering works spot. It can use usefully at base rock or concrete laying because is insulated with excellent biographical special quality and waterproofed.

Signal cable	Use	Application site
PVC cable	Standard	On site that which have pollution
PVC shielded cable	Standard	Connect to electrical sensor at noise environment
PU cable	Standard	On site that which have pollution
Silicone cable	High temp.	Make concrete pile of high temp.
Aramid fiber reinforced PU cable	Heavy duty	Dam site(big displacement) or demand the durability

We are **ACE INSTRUMENT CO., LTD.**
which manufactures the highest value of civil
engineering measurement instrumentation.

These products are the crystallization that was created by the continuous research and development of our engineers. We are trusted as a partner of civil engineering / architecture / rock / geology experts in overseas and expect to be loved in global industry through customer impressions.





ACE INSTRUMENT CO., LTD.

The first value in Geotechnical Instrumentation
www.aceinstrument.com

www.aceinstrument.com

Tel 031-459-8753 Fax 031-459-8758

E-mail acens@naver.com

[Notice] • The products contained in this catalogue can be changed without any notification for improving the products.
• We can provide the custom products which are not contained in this catalogue.